

REV.	DESCRIPTION	DATE
1	PRELIMINARY	Oct.26,2018

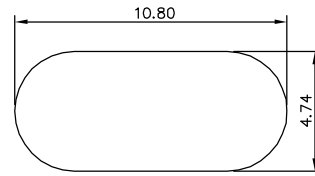
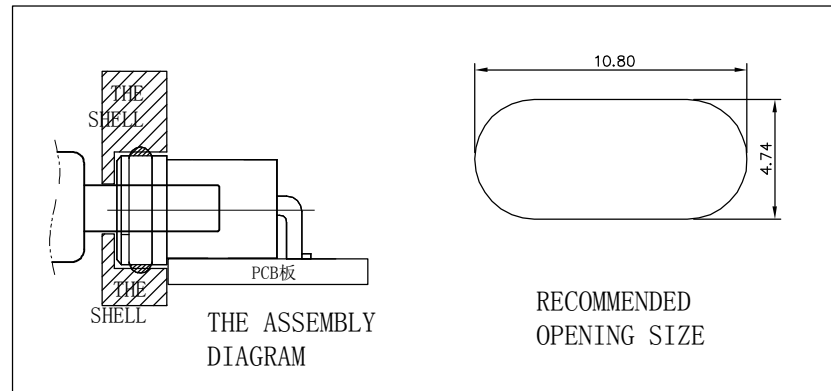
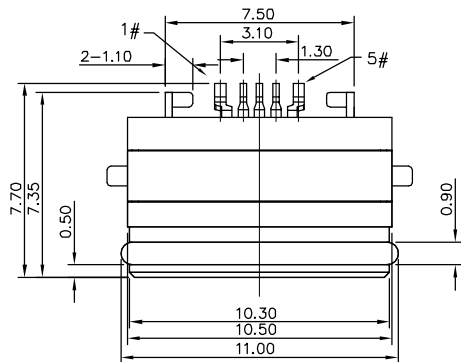

MATERIALS

- HOUSING: HIGH TEMPERATURE THERMOPLASTIC, BLACK.
- OUTER SHELL: HIGH TEMPERATURE THERMOPLASTIC, BLACK.
- TERMINAL: COPPER ALLOY.
GOLD PLATED ON CONTACT AREA.
- INNER SHELL: COPPER ALLOY OR STAINLESS.
PLATING: NICKEL PLATED.
- U-SHAPED FRAME: COPPER ALLOY OR STAINLESS.
PLATING: NICKEL PLATED.
- GLUE: BLACK.
- OVAL RING: RUBBER, BLACK.

SPECIFICATION

- CURRENT RATING: 3A(PIN1&5), 0.5A(PIN2&3&4)
- DIELECTRIC WITHSTANDING VOLTAGE :
500V AC R.M.S. FOR ONE MINUTE.
- INSULATION RESISTANCE: 1000MΩ MIN.
- CONTACT RESISTANCE: 30mΩ MAX.
- OPERATING TEMPERATURE: -25°C TO +85°C.
- DURABILITY: 10000 CYCLES.
- MATING FORCE: 3.5kgf(35N) MAX.
- UNMATING FORCE: 0.8kgf(8N) MIN.
- WATER PROOFNESS:
THIS PRODUCT IS BASED ON IP68(1.5-30m,30min)
- PLUG INTERFACE DIMENSIONS COMFORM TO USB2.0 SPEC.

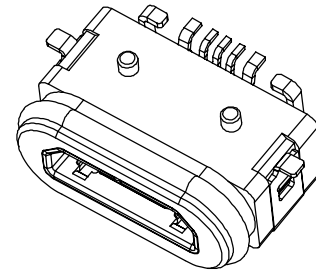
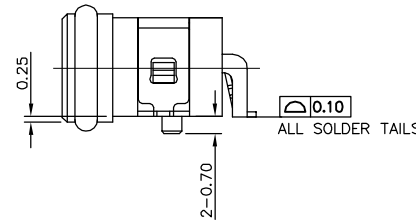
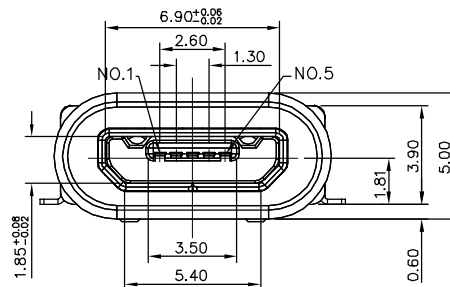

3D VIEW

PART NUMBER INFORMATION :

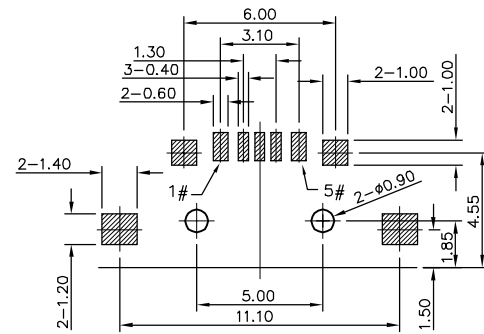
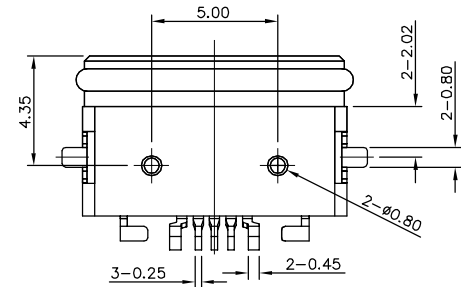
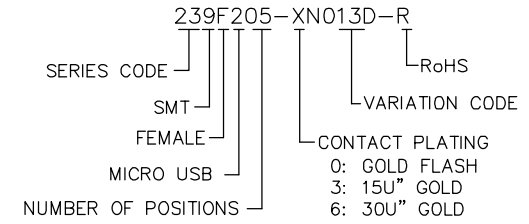

RECOMMENDED P.C.B. LAYOUT (TOP VIEW)
GENERAL TOLERANCE: ±0.05

Contact Number	Signal Name	Remarks
1#	VBUS	Power
2#	D-	Date-
3#	D+	Date+
4#	ID	Reserve or Gound
5#	GND	Gound

TOLERANCE 0.=±0.30 .0=±0.20 .00=±0.15 .000=±0.10 ANG.=±3°		DRAWER <i>DLM</i>	 ASTRON TECHNOLOGY CORP.
UNITS : mm		CHECK <i>SPURD FU</i>	
SCALE NONE SIZE A4		APP'D <i>SPURD FU</i>	NAME MICRO USB 2.0 B TYPE RECEPTACLE
SHEET 1 OF 1		PRODUCT SPEC. —	DRAW NO. 239F205-XN013D-R
REV. 1			